

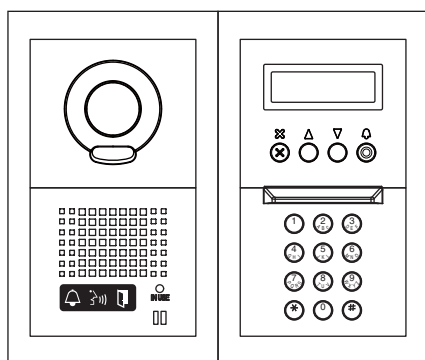

GT SYSTEM

Apartment Intercom System Entrance Station (Unit Type)/Entrance Station (Integrated Type)/ Security Guard Station



Entrance Station (Unit type)

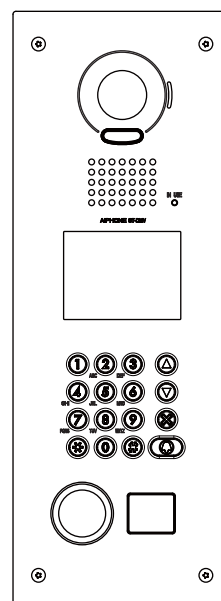

Entrance Station
(Integrated type)

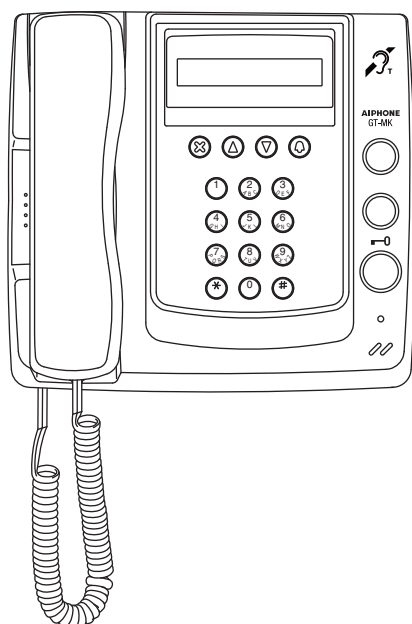

Security guard station

PRECAUTIONS

-  General Prohibitions  Prohibition to Dismantle the Unit  Prohibition on Subjecting the Unit to Water  General Precautions

WARNING

(Negligence could result in death or serious injury.)

1. Do not dismantle or alter the unit. Fire or electric shock could result.
2. Do not connect non-specified power sources to the +, - terminals. Also, do not install two power supplies in parallel to a single input. Fire, damage, or system malfunction could result.
3. Keep the unit away from water or any other liquid. Fire or electric shock could result.
4. Do not put any metal or paper into the unit through the openings. Fire, electric shock, or unit trouble could result.
5. High voltage is present internally. Do not open the case. Electric shock could result.
6. Do not use a power supply with a voltage other than the specified. Fire or electric shock could result.

CAUTION

(Negligence could result in injury to people or damage to property.)

1. Do not place (install) the unit in locations subject to frequent vibration or impact. Injury or damage could result if the unit falls.
2. Do not press on the LCD or subject it to high impact. The LCD glass could break which could result in an injury.
3. If the LCD is punctured, do not allow skin contact with the liquid crystal inside. Inflammation could result.
 - * If liquid crystal is ingested, immediately gargle with water and seek medical attention.
 - * If contact with the eyes or skin occurs, clean with pure water for at least 15 minutes and seek medical attention.
4. Do not install the unit in any of the following locations. Fire, electric shock, or unit trouble could result.
 - * Places under direct sunlight or places near heating equipment that varies in temperature.
 - * Places subject to dust, oil, chemicals, etc.
 - * Places subject to moisture and humidity extremes, such as bathrooms, cellars, greenhouses, etc.
 - * Places where the temperature is quite low, such as inside a refrigerated area or in front of an air conditioner.
 - * Places subject to steam or smoke (near heating or cooking surfaces).
 - * Where noise generating devices such as dimmer switches or inverter electrical appliances are close by.
5. Do not put anything on or cover the unit with cloth, etc. Fire or unit trouble could result.
6. For power supply, use Aiphone power supply model or model specified for use with system. If non-specified product is used, fire or malfunction could result.
7. When performing call tests or checking the chime volume or call volume, make sure the handset is placed on the main unit. Failure to do so may result in injury to the ears.

General Precautions

1. The unit turns inoperative during power failure.
2. In areas where broadcasting station antennas are close by, intercom system may be affected by radio frequency interference.
3. Keep the unit more than 1 m away from radios or TV sets.
4. Be careful about where the unit is used, as use of computers, televisions, or radios near the unit may affect transmission from the unit or cause unwanted noise.
5. When wall-mounted, the top of the unit may darken. This does not indicate a malfunction.
6. If the unit is down or does not operate properly, turn off the unit's power supply.
7. The unit case may become warm with use, but this is not a unit malfunction.
8. If the surface of an entrance station freezes during wintertime, the picture may become difficult to see or the buttons may not move, but this is not a malfunction.
9. Security guard stations are for indoor use only. Do not use outdoors.
10. If a strong light shines on the main unit screen, the picture will turn white or only silhouettes will be visible. But this is not a unit malfunction.
11. As to other manufacturer's devices (such as sensor, detectors, door releases) used with this system, comply with the Specifications and Warranty conditions that the manufacturers or vendors present.
12. If a cellular phone is used close by, the unit may malfunction.
13. The LCD panel is manufactured with very high precision techniques. Please be aware of this in advance.
14. Talk within 50 cm (20") or less from the unit. If you stand too far away, it may be difficult for the other person to hear the communication.
15. If there are loud noises around the unit (such as music playing or children crying), the sound may break up and be difficult to hear.
16. During communication, if you speak before the other person has finished talking, your voice may not come through clearly. Communication will proceed smoothly if you wait until the other person has finished before speaking.
17. The outline of video images displayed by an entrance station may differ from that of the actual person(s) or background, but this is not a malfunction.
18. When putting a hearing aid into T-mode and approaching the unit, the intercom system may be affected by radio frequency interference etc., depending on the installation environment.
19. The sensor of an entrance station (integrated type) may activate due to moving shadows or moving tree branches, etc. and cause a message to display, but this is not a malfunction.

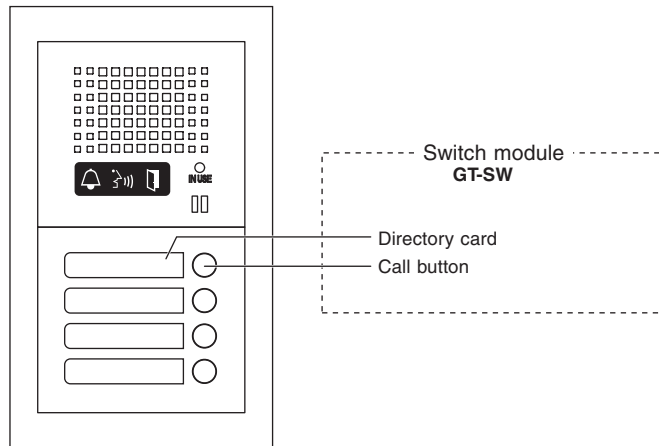
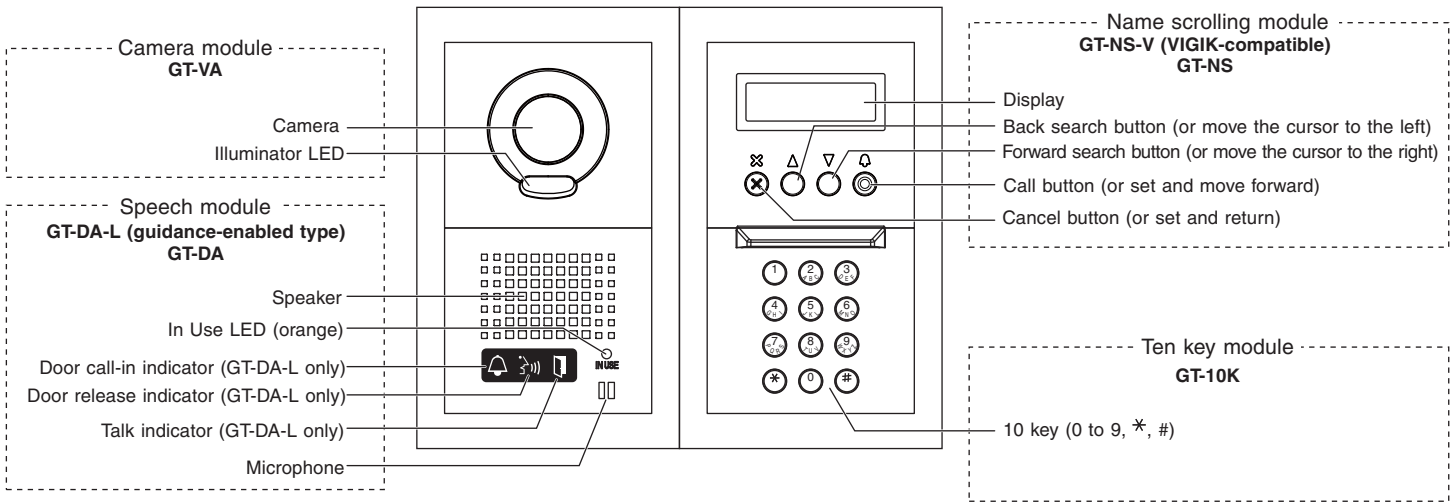

Table of Contents

1	NAMES	
	Entrance Station (Unit type).....	4
	Entrance Station (Integrated type)	5
	Security guard station.....	5
2	OPERATIONS (ENTRANCE STATION)	
	Calling residential stations	6
	Calling security guard stations	8
	Door release	8
3	OPERATIONS (SECURITY GUARD STATION)	
	Calling from an entrance station.....	9
	Door release	9
	Light control	9
	Calling from a residential station.....	10
	Calling from the doorbell button.....	10
	Calling entrance stations	10
	Calling residential stations	11
	Calling another security guard station	12
	Missed call	13
	Call transfer/Communication transfer.....	13
	Emergency call.....	14
4	Setting list	
	Setting list	15
5	CHANGING SETTINGS (ENTRANCE STATION)	
	Setting method.....	16
	Display language selection	17
	Guidance language selection	17
	Changing the ID code.....	18
	Access code setting	18
	Changing resident information.....	19
	Setting messages and the standby screen.....	20
	Adjusting screen brightness.....	21
	Setting the search order.....	21
6	CHANGING SETTINGS (SECURITY GUARD STATION)	
	Setting method.....	22
	Display language selection	22
	Changing the ID code.....	22
	Changing resident information.....	23
	Setting the search order.....	23
7	TECHNICAL PRECAUTIONS.....	24
8	SPECIFICATIONS	24

1 NAMES

1-1 Entrance Station (Unit type)



Combination examples for entrance stations

Audio only, Direct Select type
(8 stations)

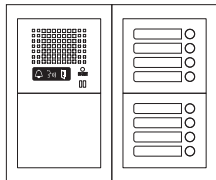

Audio/video, Direct Select type
(8 stations)

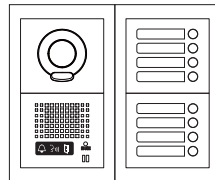

Audio only, 10 key type

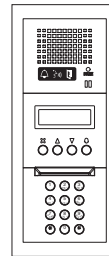

Audio/video, 10 key type

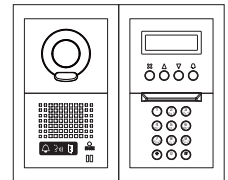

1-2 Entrance Station (Integrated type)

GT-DMV (Guidance-enabled + VIGIK-linked type)

GT-DM (Guidance-enabled type)

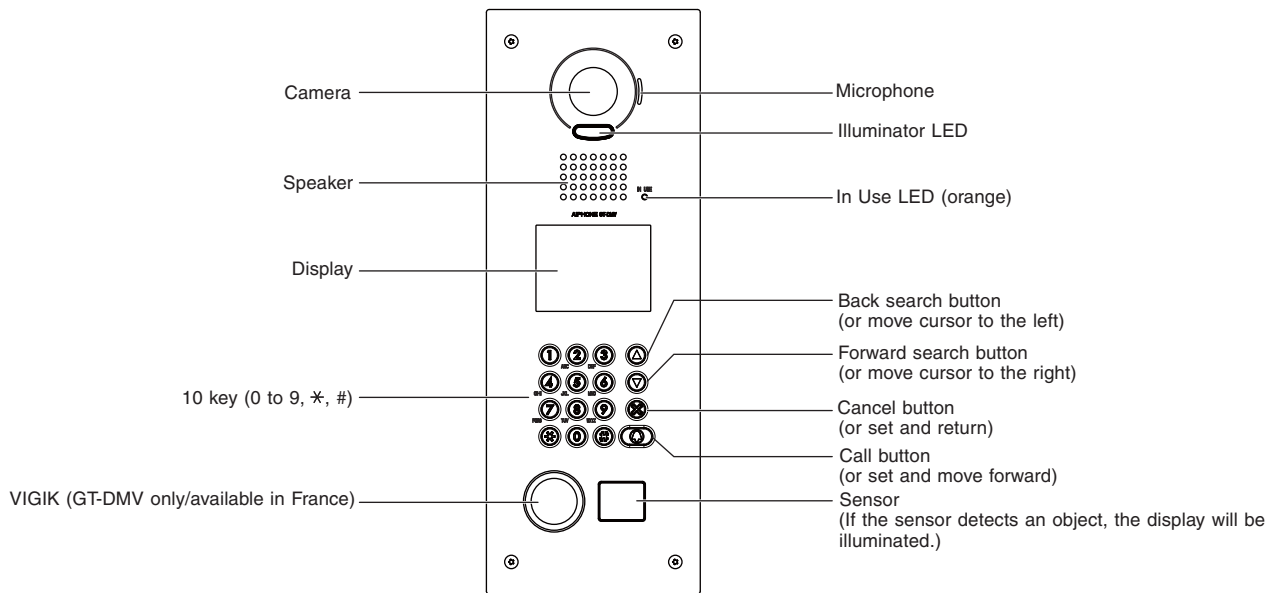

1-3 Security guard station

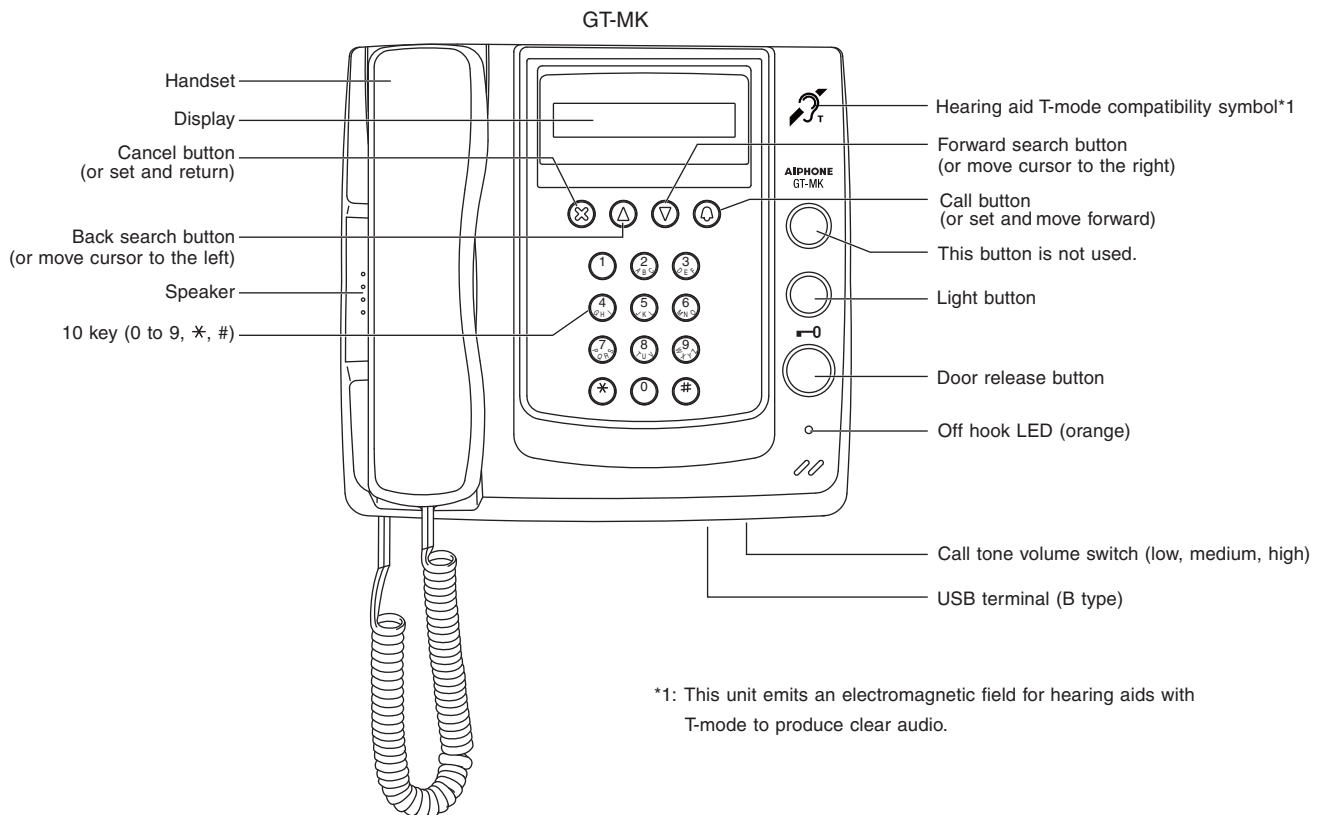

2 OPERATIONS (ENTRANCE STATION)

2-1 Calling residential stations

Calling with the switch module

Press the call button for the residence that you want to call.

The door call-in indicator will light up and you will hear a call tone. Audio guidance will be heard depending on the settings.

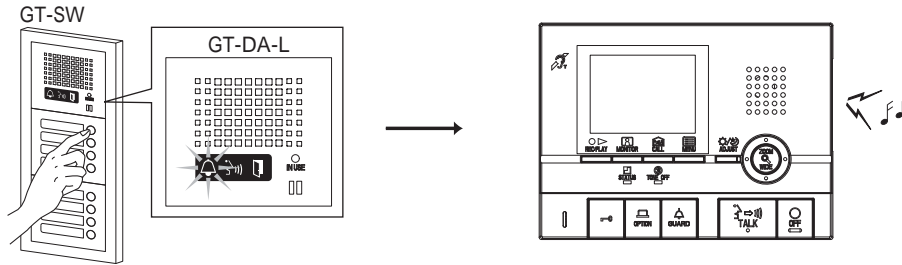

Calling with the name scrolling module or GT-DMV/GT-DM.

Display the residential station to be called.

(1) Display using scrolling to search

1 In the standby mode, use the Δ and ∇ buttons to display the room number and resident name.

Use the Δ and ∇ buttons to search for the desired residential station.

- Depending on the settings, the resident name may only display.
- The display order may be according to room number or name.

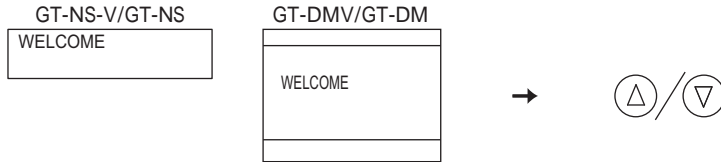

2 Press the \odot button.

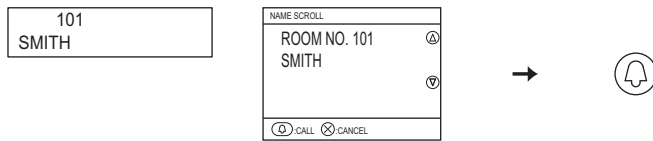

(2) Display using room number to search

1 In the standby mode, enter the room number using [0] to [9] on the 10 key to display the room number and resident name.

- Depending on the settings, the resident name may only display.

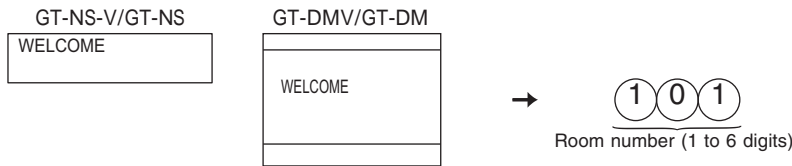

2 Press the \odot button.

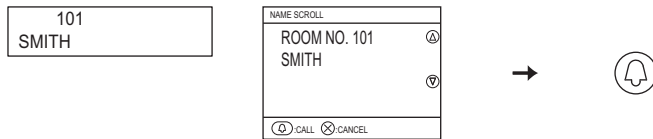

* If there is no relevant room number, the message below is displayed.

GT-NS-V/GT-NS NO ENTRY	GT-DMV/GT-DM < NO ENTRY >
---------------------------	------------------------------

* When the trunk of the residential station that has been called is in use, the in use LED lights up to indicate that the residential station cannot be used.

(3) Display by using letters to search

1 In the standby mode, press [*] on the 10 key.

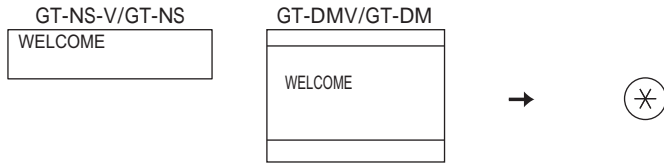

2 When "ENTER A LETTER" displays, use the 10 key to enter letters.

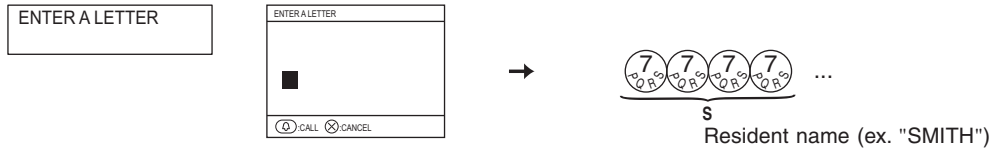

3 The room number and name for the resident whose initial corresponds to the entered letter will display.

- Depending on the settings, the resident name may only display.

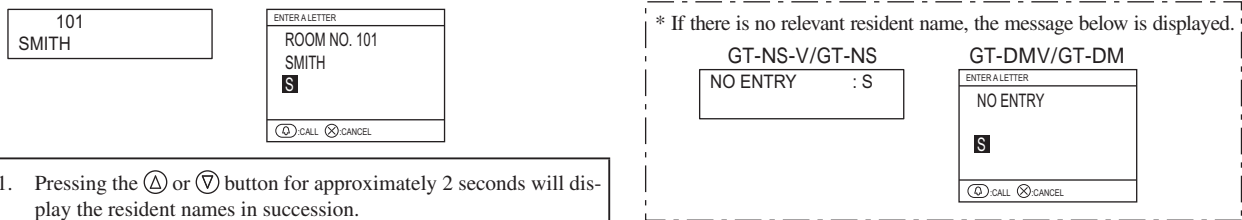

NOTES: 1. Pressing the Δ or ∇ button for approximately 2 seconds will display the resident names in succession.
 2. If both room number 111 and 1111 exist, the resident name for room 111 will be displayed when 1, 1, 1 is entered, and the resident name for room 1111 will be displayed if 1 is entered one more time.
 3. Stations can be made to display in order by room number using the menu screen settings. (The order starts with the lowest digit from 0 to 9 and then the order goes by letter.) In cases where room numbers such as A101, A201, A901, A1001, and B101 exist, the order starts with the lowest digit and goes in the order A101, A201, A901, B101, A1001.

Call the residential station after it is displayed.

4 When the desired residential station is displayed, press the $\text{\textcircled{C}}$ button. The door call-in indicator will light up and you will hear a call tone. Audio guidance will be heard depending on the settings.

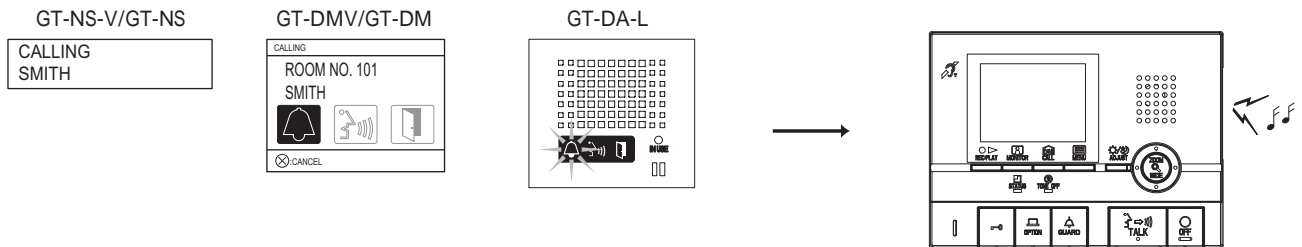

- 5 When the other person answers, communication starts and the talk indicator lights up. Audio guidance will be heard depending on the settings.

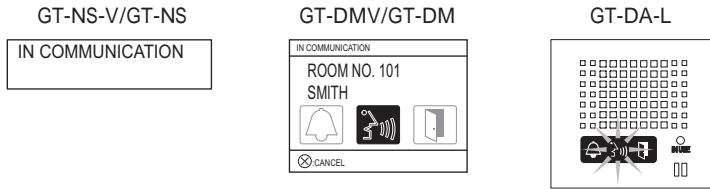

- 6 When the door is released, the door release indicator lights up. Audio guidance will be heard depending on the settings.

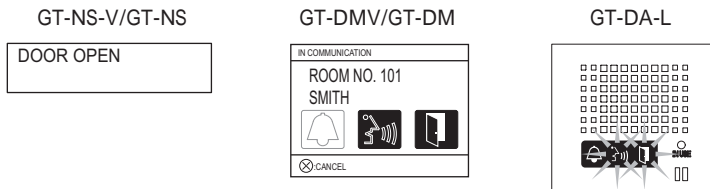

2-2 Calling security guard stations

Select the security guard station and press the  button. You will hear a call tone. Audio guidance will be heard depending on the settings.

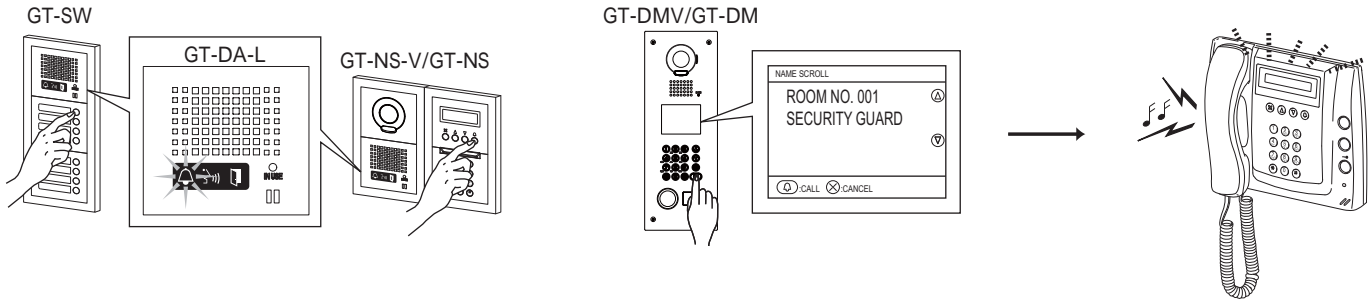

2-3 Door release

- 1 In the standby mode, enter the access code (4 to 6 digits) after entering [#] on the 10 key. Audio guidance will be heard depending on the settings.

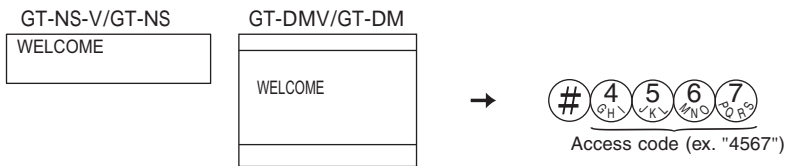

- 2 The door is released.

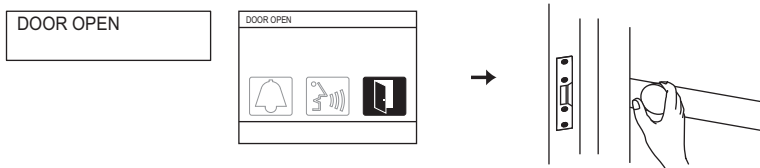

* If the access code is incorrect, the message below is displayed.

GT-NS-V/GT-NS DENIED	GT-DMV/GT-DM < DENIED >
-------------------------	----------------------------

3 OPERATIONS (SECURITY GUARD STATION)

3-1 Calling from an entrance station

- 1 When the call is from an entrance station, the call tone will ring for approximately 10 seconds and the entrance station number will be displayed.

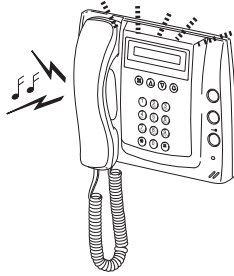

- 2 Lift the handset to respond.



- 3 When you are done talking, hang up the handset to end the call.
 - Communication ends automatically after approximately 3 minutes.

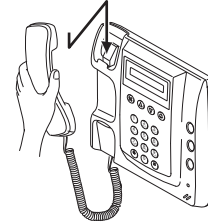

- ⚠ With the expanded system, the display number of the entrance station varies depending on the common line connection of the entrance station and security guard station.

Connected to same common line: "Set number" is displayed as is

Ex.) Call from entrance station #1: "MAIN ENTRANCE: 01" is displayed

Connected to separate common line: "Set number + 8"

Ex.) Call from entrance station #1: 1 + 8 = 9, so "MAIN ENTRANCE: 09" is displayed

3-2 Door release

- 1 Press the door release button while in communication with the entrance station.



- 2 Door release is activated at the entrance station.

- ⚠ Depending on the electric door release system that you use, door release may be active only while the door release button is pressed.



3-3 Light control

Turning the entrance light on (when light is installed in common area)

- 1 Press the light button once during calling or communication from the entrance station.



- 2 The outside light at the entrance will only turn on for the preset duration of time.



- ⚠ This function is not available if a surveillance camera is installed in the common area.

3-4 Calling from a residential station

- 1 When a call is received from a residential station, a call tone will sound for approximately 10 seconds and the room number and resident name will be displayed.

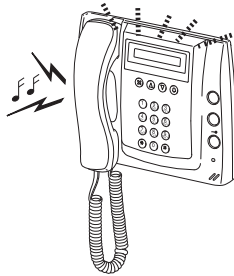

- 2 Lift the handset to respond.



- 3 When you are done talking, hang up the handset to end the call.

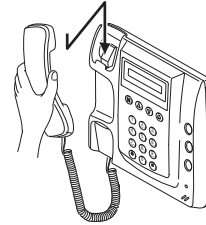

NOTES: If a call is not responded to, a record is kept.

- ⚠ The communication will be ended automatically after approximately 1 minute when hands-free communication is used at the residential station or after approximately 3 minutes when the handset is used.

3-5 Calling from the doorbell button

- 1 When the doorbell button is pressed, a call tone will sound while the button is being pressed.
 - A different call tone sounds. (Communication is not possible.)



3-6 Calling entrance stations

- 1 Lift the handset and press the 10 key [*] button.



- 2 Use the 10 key to select the desired entrance station.

⚠ With the expanded system, the display number of the entrance station varies depending on the common line connection of the entrance station and security guard station.

Connected to same common line: "Set number" is displayed as

Ex.) Calling entrance station #1: Enter [1]

Connected to separate common line: "Set number + 8"

Ex.) Calling entrance station #1: 1 + 8 = 9, so enter [9]



- 3 Press the @ button to communicate with the entrance station. If there is no corresponding entrance station, "DENIED" will be displayed.

- While in communication, you can use the light button and door release button.

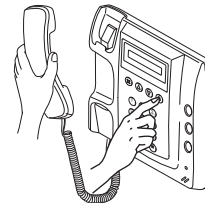

- 4 When you are done talking, hang up the handset to end the call.

- Communication ends automatically after approximately 3 minutes.

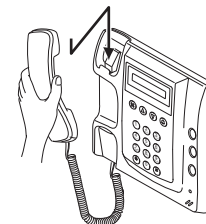

3-7 Calling residential stations

Lift the handset, display the name and press the **Ⓢ** button.

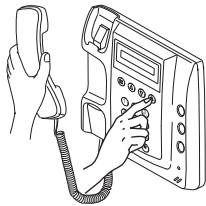

Making a call by name scrolling

Use the **Ⓢ** and **Ⓡ** buttons to search names by scrolling.

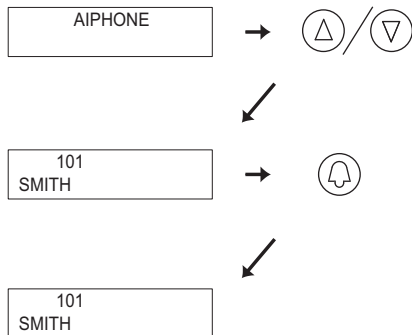

- NOTES:
1. Pressing the **Ⓢ** or **Ⓡ** button for approximately 2 seconds will display the resident names in succession.
 2. If both room number 111 and 1111 exist, the resident name for room 111 will be displayed when 1, 1, 1 is entered, and the resident name for room 1111 will be displayed if 1 is entered one more time.
 3. Stations can be made to display in order by room number using the menu screen settings. (The order starts with the lowest digit from 0 to 9 and then the order goes by letter.) In cases where room numbers such as A101, A201, A901, A1001, and B101 exist, the order starts with the lowest digit and goes in the order A101, A201, A901, B101, A1001.

Making a call by entering the room number

Enter the room number with the 10 key.

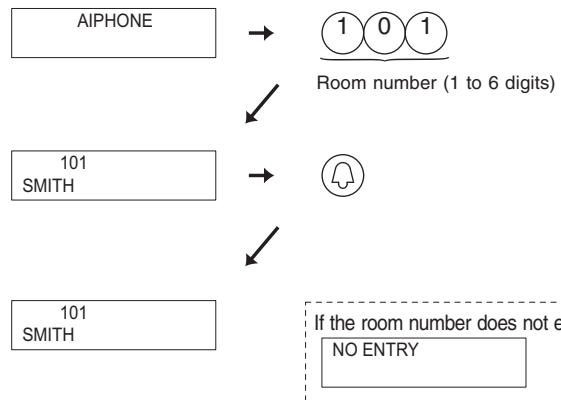

Making a call by entering a letter and selecting a corresponding name

Press [*****] on the 10 key to display "ENTER A LETTER", enter an initial with the 10 key and then press the **Ⓢ** button.

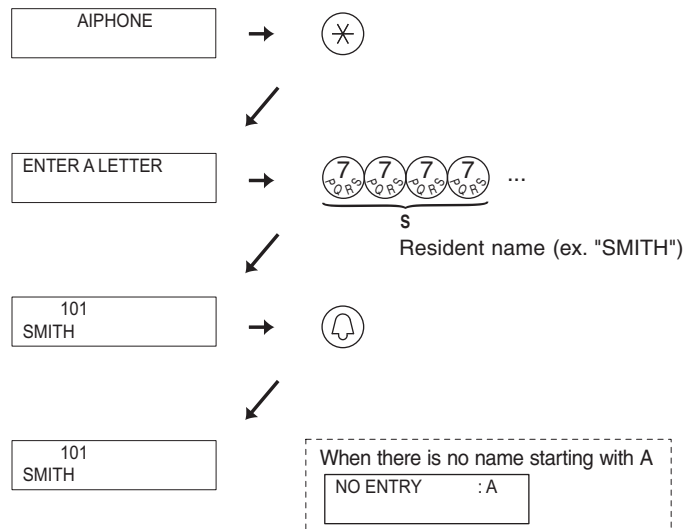

1. The communication will be ended automatically after approximately 1 minute when hands-free communication is used at the residential station or after approximately 3 minutes when the handset is used.
2. This function may not be usable depending on the equipment being used.

3-8 Calling another security guard station

Lift the handset, display the security guard station and press the **☎** button.

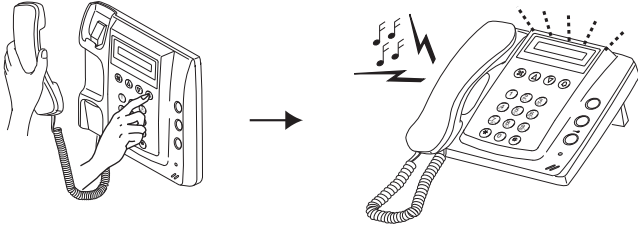

Making a call by security guard station name scrolling

Use the **⬆** and **⬇** buttons to search security guard station names by scrolling.

AIPHONE → **⬆** / **⬇**

001 SECURITY GUARD A → **🔔**

001 SECURITY GUARD A

Making a call by entering the security guard station number

Enter the security guard station number with the 10 key.

AIPHONE → **0 0 1**
Room number (1 to 6 digits)

001 SECURITY GUARD A → **🔔**

001 SECURITY GUARD A

If the room number does not exist
NO ENTRY

Making a call by entering letters and selecting the corresponding security guard station

Press [*****] on the 10 key to display "ENTER A LETTER", enter a security guard station name with the 10 key and then press the **☎** button.

AIPHONE → *****

ENTER A LETTER → **7 7 7 7** ...
S

Security guard station name
(Ex.: [SECURITY GUARD A])

001 SECURITY GUARD A → **🔔**

001 SECURITY GUARD A

When there is no security guard station name starting with S

NO ENTRY : S

- NOTES: 1. Pressing the **⬆** or **⬇** button for approximately 2 seconds will display the resident names in succession.
2. If both room number 111 and 1111 exist, the resident name for room 111 will be displayed when 1, 1, 1 is entered, and the resident name for room 1111 will be displayed if 1 is entered one more time.

Making a call using the ID

After pressing [*****] and [**1**] on the 10 key, enter [0] plus the security guard station ID number (1 to 4), and then press the **☎** button.

- You will hear a low-volume call tone from the handset.

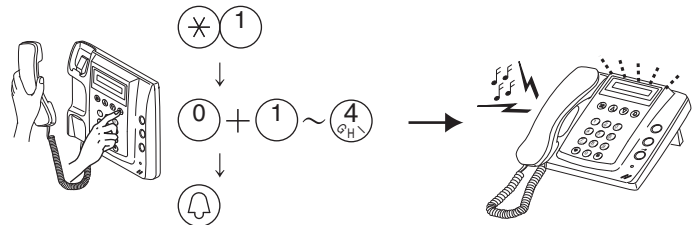

⚠ With the expanded system, the security guard station number varies depending on the common line connection of the security guard station.

Connected to same common line: "Set number" is displayed as is

Ex.) Calling security guard station #1: Enter [1]

Connected to separate common line: "Set number 2"

Ex.) Calling security guard station #1: 1 + 2 = 3, so enter [3]

NOTES: If the security guard station does not exist, "DENIED" will be displayed.

3-9 Missed call

- 1 If a security guard station fails to respond to a call from a residential station, "MISSED CALLS" is displayed on the display. Press the  button to display the room number and name of the residential station that made the call.



- 2 When the room number and name is displayed, lift the handset and press the  button to call the residential station that is displayed.

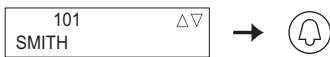

- 3 When the room number and name is displayed, press the  button to erase the displayed record. Other records will not be deleted.



NOTES: 1. The security guard station can hold up to 20 missed calls.
2. A record of answered calls is not kept.

3-10 Call transfer/Communication transfer

In the standby mode, press [$*$], [1] and [$*$] to display "RECEPTION MODE". In this mode, you can transfer all calls from an entrance to the security guard station.

Press [$*$], [1] and [$*$] again to cancel the setting.

NOTES: 1. If there are multiple security guard stations, you can make and cancel the transfer setting on any security guard station to switch the setting for the system overall.
2. Calls from an entrance station are transferred to all security guard stations that are linked to the corresponding residential station. The call tone sounds on all security guard stations at the same time.
3. A call to a residential station that is not linked to a security guard station will result in a call to the residential station directly.

- 1 In "RECEPTION MODE", all of the calls from entrance stations to residential stations are transferred to security guard stations. The call tone sounds, and then the called room number and name flash on the screen along with the entrance station number.

- 2 Lift the handset to communicate with the entrance station.

- 3 When transferring a call to the called residential station, press the  button.

- 4 After the residential station answers, hang up the handset to establish communication between the entrance station and the residential station.

When there is no one at the residential station, hang up the handset and pick it up again to communicate with the entrance.

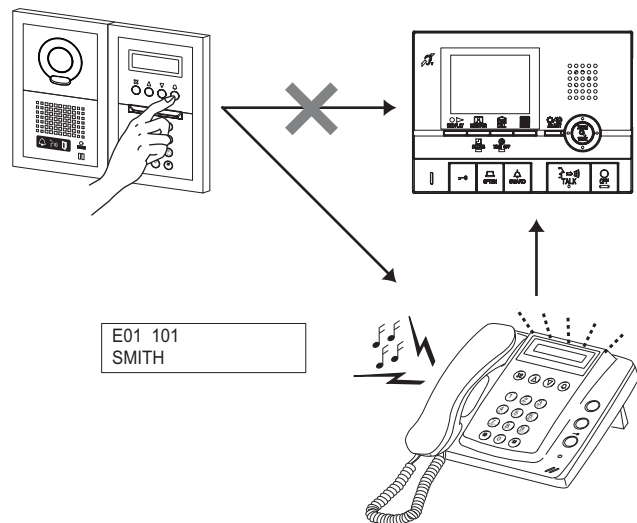

3-11 Emergency call

- 1 When an emergency alarm switch is locked (or when a wire disconnection occurs), an alarm sounds at the security guard station and "EMERGENCY" and the room number are displayed alternately. Press the ☒ button to stop the alarm.
- 2 Lift the handset, check the name on the display and press the Ⓜ button to communicate with the residential station.

NOTES:

1. If an emergency call is already active on a security guard station and that station is in communication, another security guard station cannot interrupt. (An in-use tone will be heard from the handset of the security guard station.)
2. The emergency alarm is given priority even when the system is in use. (Alarms can be activated at the same time for up to 5 units. This excludes GT-2C-L and GT-2C.)
3. When a security guard station has received multiple emergency alarms, an arrow will be shown to the right of "EMERGENCY" on the display.
4. When the arrow is displayed, you can use the Ⓜ and Ⓨ buttons to select another residential station.
5. Emergency calls while the system is in use can be made after other communication is terminated.
6. With the GT-2C-L and GT-2C, it is possible to transfer to a security guard station even when there is a security alarm, depending on the settings.

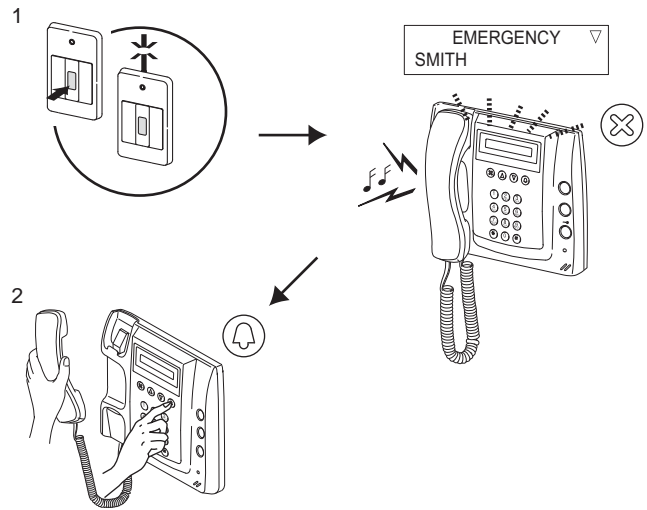

4 Setting list



4-1 Setting list

The following settings are possible at an entrance station or security guard station.

- The program menu varies according to the unit.

- × = These items are set when a unit is installed. When making changes, consult with an qualified installer.

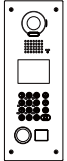
- = These items can be set according to the installation equipment and unit application.

Setting item	Description	GT-NS-V/GT-NS, GT-DA-L/GT-DA, GT-VA 	GT-DMV/GT-DM 	GT-MK 	Page no.
SELECT LANGUAGE	Select the display language.				17, 22
GUIDE LANGUAGE	Select the guidance language.	×			17
CHANGE ID CODE	Change the ID code.				18, 22
ACCESS CODE	Set the access code for door release at the entrance station.				18
RESIDENT INFO.	Enter and change resident data (names and room numbers).				19, 23
SET TIMER	Set various timers.	×	×	×	-
CHANGE GREETING	Change the greeting message.				20
PROGRAMMING	Perform link settings.	×	×	×	-
TRANSFER DATA	Transfer link information to another entrance station or security guard station.	×	×	×	-
VERIFY PROGRAM	Perform a link check.	×	×	×	-
SCROLL SPEED	Set the scroll speed for display messages and resident names, etc.	×	×	×	-
MONITOR ENTRANCE	Select the setting for monitoring with the entrance station camera from a residential station.	×	×	×	-
CALL-IN DISPLAY	Select the screen switching for residential stations when a call is received.	×	×		-
LIGHT OR CCTV	Select the operation performed when the light button on a residential station is pressed.	×	×		-
DISPLAY ROOM NO.	Select room number display for the screen display.	×	×		-
STANDBY SCREEN	Select the standby screen.				20
BRIGHTNESS	Adjust the screen brightness.				21
SORT SETTING	Select the display order during searching.				21, 23
OPTIONAL OUTPUT	Perform settings for outputting signals to security guard stations and for outputting signals from the emergency alarm RY-RY terminal.			×	-
QUIT	Quit the program mode.				16, 22

5 CHANGING SETTINGS (ENTRANCE STATION)

5-1 Setting method

When changing settings, use the GT-NS-V/GT-NS or GT-DMV/GT-DM program mode.

Program Mode

- 1** In the standby mode, enter the 4-digit ID code after entering [#] and [*] on the 10 key. (Initial setting: 1111)

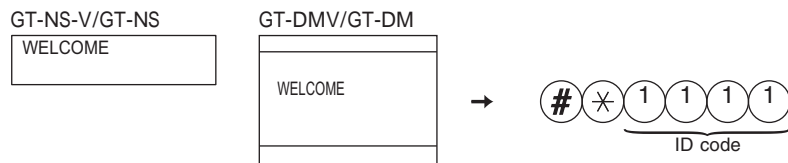

- 2** The "RE-ENTER ID CODE" is displayed. Re-enter [*] and the 4-digit ID code.

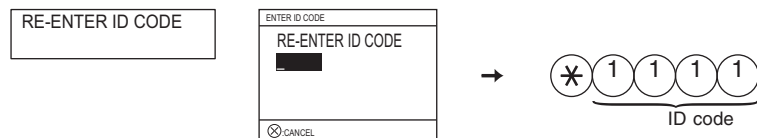

- 3** The first menu item is displayed. Use the Δ and ∇ buttons to select the desired menu item.

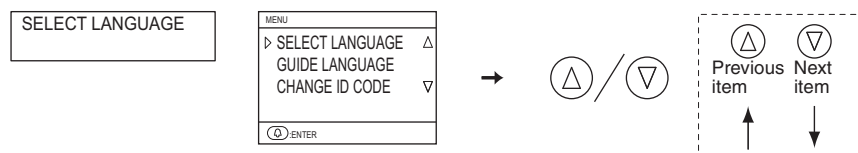

- 4** When quitting the program mode, select "QUIT" and press the ⊗ button.

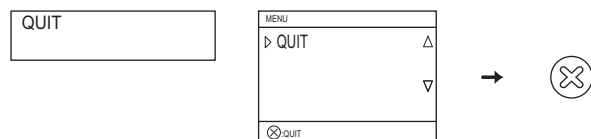

5-2 Display language selection

Start the program mode with the GT-NS-V/GT-NS or GT-DMV/GT-DM and select "SELECT LANGUAGE".
 Select English, French, German, Spanish, Dutch, or Italian.

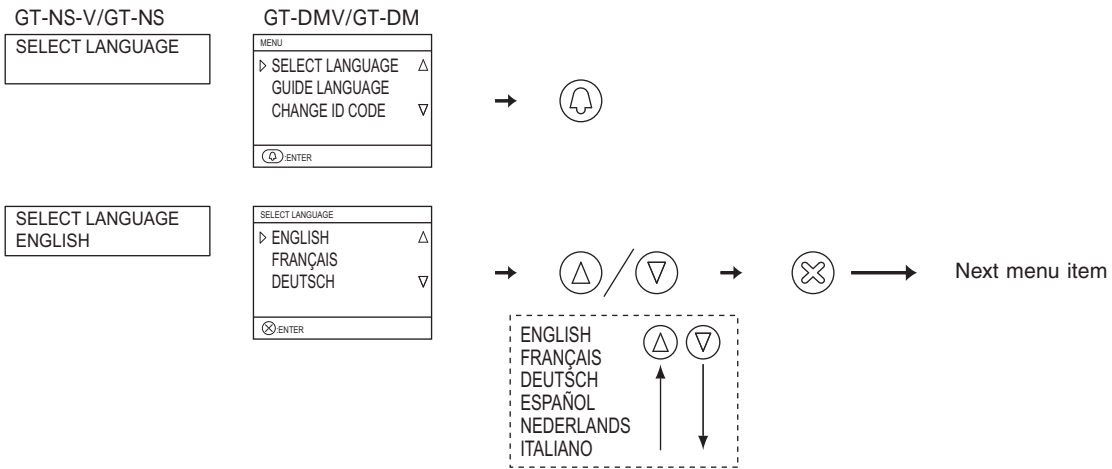

5-3 Guidance language selection

Start the program mode with the GT-DMV/GT-DM and select "GUIDE LANGUAGE".
 Select English, French, German, Spanish, Dutch, Italian or no guidance.

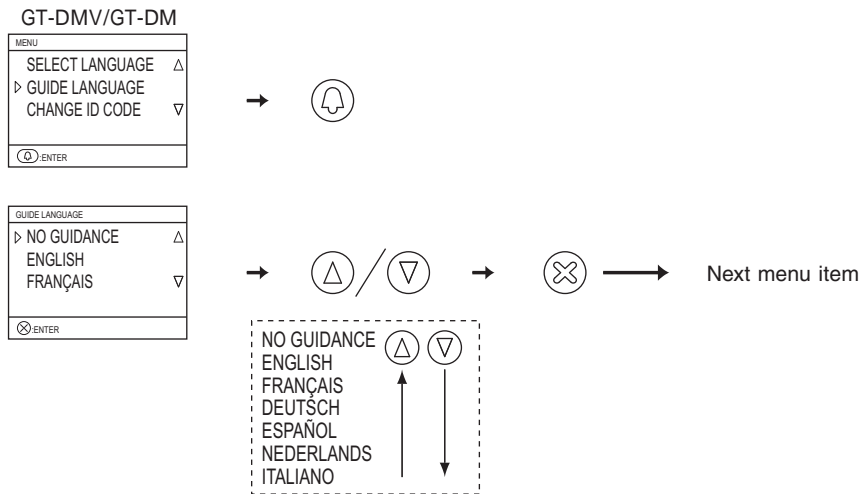

5-4 Changing the ID code

- 1 Start the program mode and select "CHANGE ID CODE".

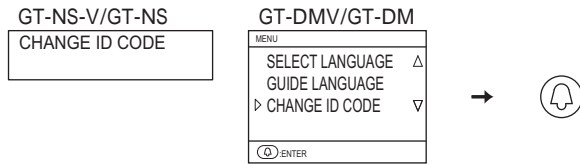

- 2 The current ID code is displayed. Enter the new 4-digit ID code after entering [*] on the 10 key.

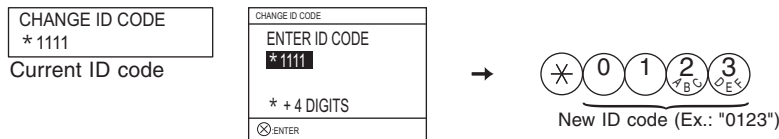

- 3 Press the [ENTER] button to return to the menu.

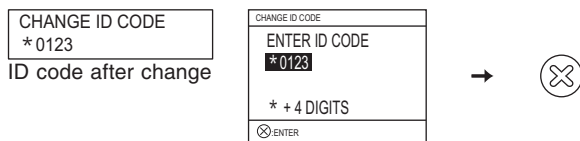

5-5 Access code setting

- 1 Start the program mode and select "ACCESS CODE".

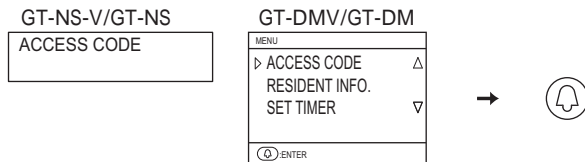

- 2 The current digit is displayed after "NO. OF DIGIT". Set a digit from 4 to 6. Enter the digit using the 10 key or, with the GT-DMV/GT-DM, select it by using the [▲] and [▼] buttons, and then press the [ENTER] button.

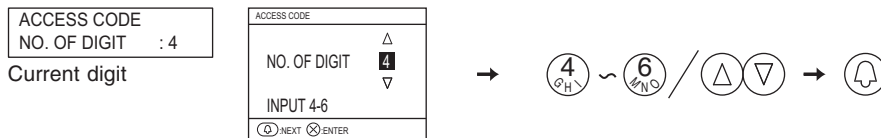

- 3 "ACCESS CODE: 001" will be displayed. Up to 500 access codes can be set. Select access codes from "001" to "500". Enter the digit using the 10 key or, with the GT-DMV/GT-DM, select it by using the [▲] and [▼] buttons, and then press the [ENTER] button.

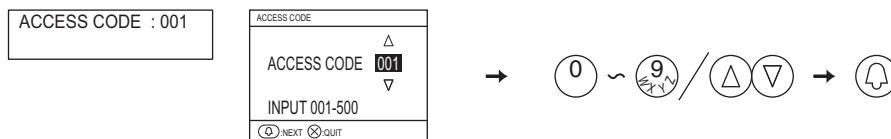

- 4 Enter the access code, and then press the [ENTER] button.
* Codes with more digits than the set number of digits for access codes cannot be entered.

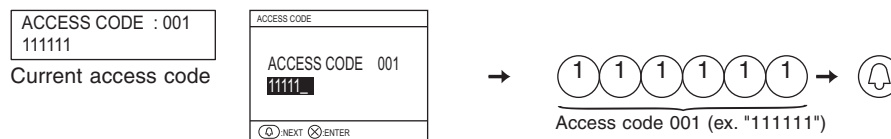

- 5 The display will change to the next access code setting screen. Press the [ENTER] button to return to the menu.

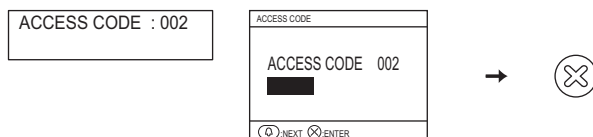

5-6 Changing resident information

Up to 500 resident information entries can be registered.

Programming with the GT-NS-V/GT-NS or GT-DMV/GT-DM

- 1 Start the program mode and select "RESIDENT INFO."

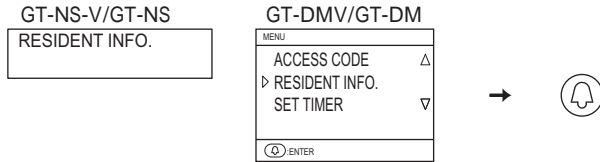

- 2 Enter the room number that is to be newly registered or have data changed using [0] to [9] on the 10 key, and then press the button. Room numbers can have up to 6 digits.

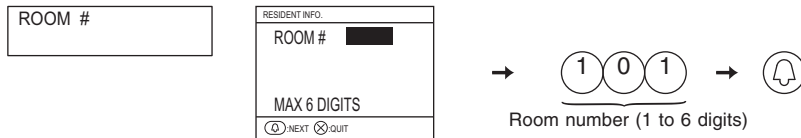

- 3 The room number is displayed. If the resident name has already been registered, it will also display. Enter or edit the resident name. Resident names can have up to 32 characters. Press [*] to delete the room number and resident name.

- Up to 4 names can be registered for the same residence. Press [#] on the 10 key to display another entry field and enter or edit a resident name in the same manner as before.

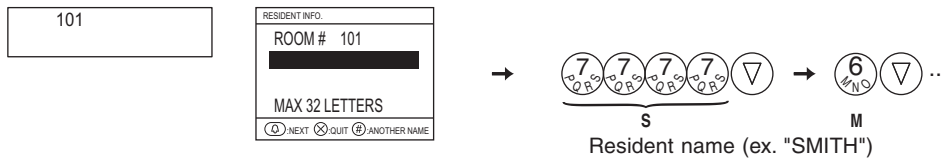

- 4 Press the button. The display will return to the room number entry screen.

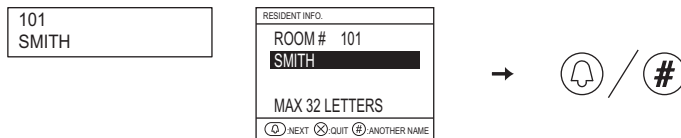

- 5 To newly register another residence or edit information, enter the room number. Press the button to return to the menu.

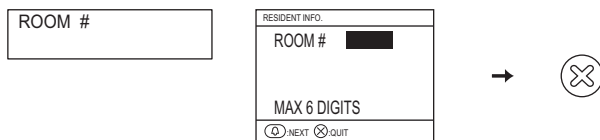

5-7 Setting messages and the standby screen

GT-DMV/GT-DM: Start the program mode and select "STANDBY SCREEN".

Select from the following in the standby screen display.

- Greeting message
- Operation message
- Original picture

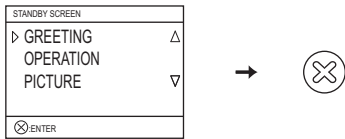
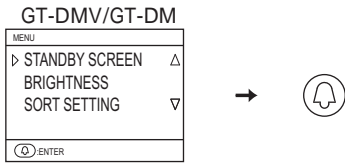

* Uploading an original picture

These items are set when a unit is installed. When making changes, consult with an qualified installer.

* Changing the greeting message

GT-NS-V/GT-NS, GT-DMV/GT-DM: Start the program mode and select "CHANGE GREETING".

Greetings can have up to 160 characters. Press [*] to delete the greeting message.

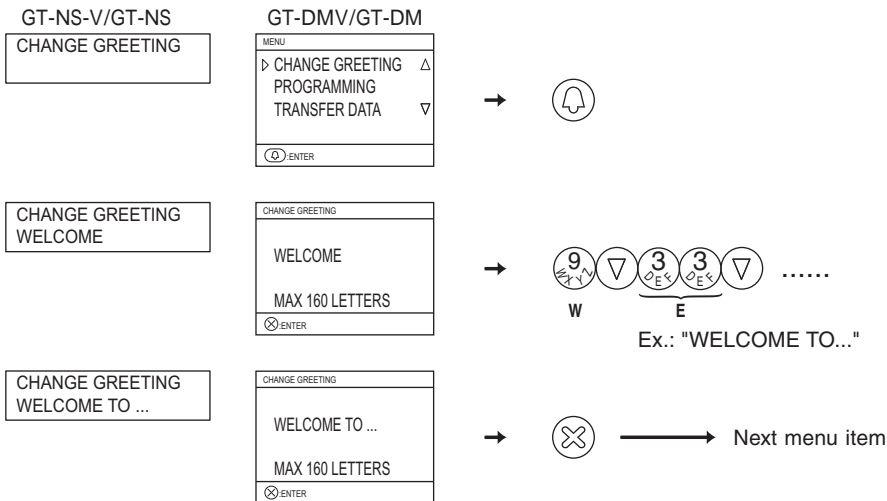

5-8 Adjusting screen brightness

Screen brightness can only be adjusted with the GT-DMV/GT-DM.

Start the program mode and select "BRIGHTNESS". Set a digit from 0 to 9. 0 = Dark 9 = Bright.

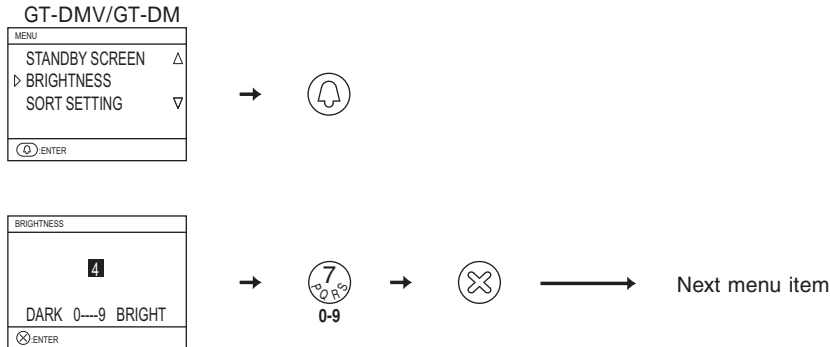

5-9 Setting the search order

Select either name order or room number order for searching at the entrance station.

GT-NS-V/GT-NS, GT-DMV/GT-DM: Start the program mode and select "SORT SETTING".

Switching between name order or room number order occurs each time the or button is pressed.

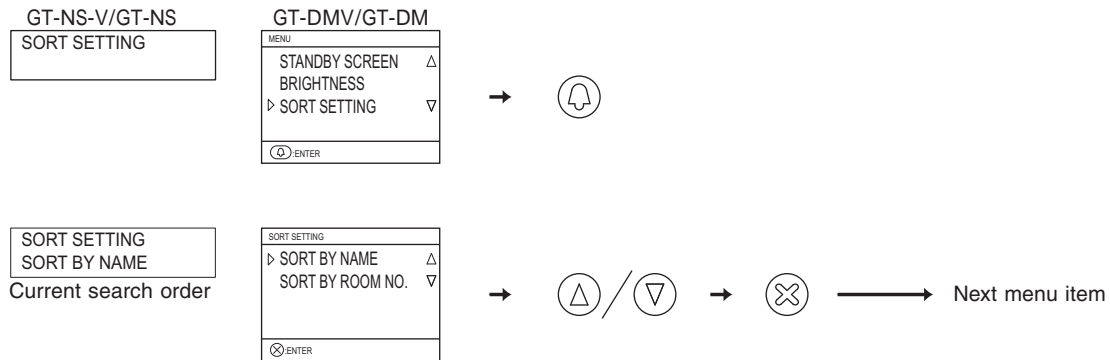

6 CHANGING SETTINGS (SECURITY GUARD STATION)

6-1 Setting method

When changing settings, use the program mode.

Program Mode

- 1 In the standby mode, enter the 4-digit ID code after entering [#] and [*] on the 10 key. (Initial setting: 1111)



- 2 The "RE-ENTER ID CODE" is displayed. Re-enter [*] and the 4-digit ID code.



- 3 The first menu item is displayed. Use the Δ and ∇ buttons to select the desired menu item.

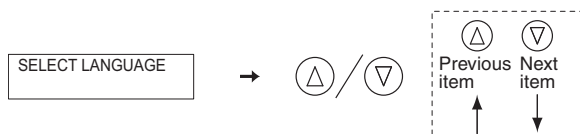

- 4 When quitting the program mode, select "QUIT" and press the \otimes button.



6-2 Display language selection

Start the program mode and select "SELECT LANGUAGE".

Select English, French, German, Spanish, Dutch, or Italian.

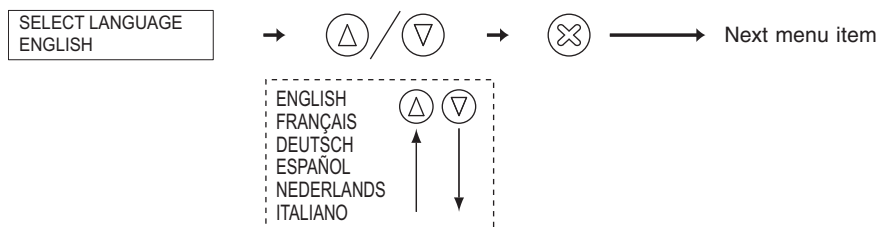

6-3 Changing the ID code

- 1 Start the program mode and select "CHANGE ID CODE".



- 2 The current ID code is displayed. Enter the new 4-digit ID code after entering [*] on the 10 key.

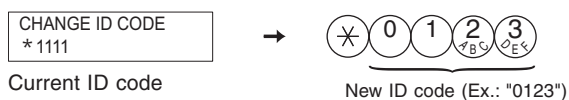

- 3 Press the \otimes button to return to the menu.

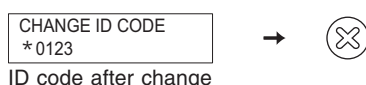

6-4 Changing resident information

Up to 500 resident information entries can be registered.

Programming with the GT-MK

- 1 Start the program mode and select "RESIDENT INFO".



- 2 Enter the room number that is to be newly registered or have data changed using [0] to [9] on the 10 key, and then press the button. Room numbers can have up to 6 digits.



- 3 The room number is displayed. If the resident name has already been registered, it will also display.

Enter or edit the resident name. Resident names can have up to 32 characters. Press [~~*~~] to delete the room number and resident name.

- Up to 4 names can be registered for the same residence. Press [#] on the 10 key to display another entry field and enter or edit a resident name in the same manner as before.

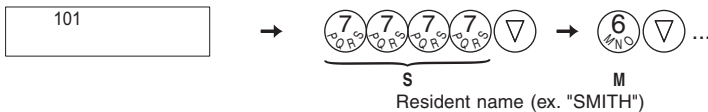

- 4 Press the button. The display will return to the room number entry screen.



- 5 To newly register another residence or edit information, enter the room number. Press the button to return to the menu.



6-5 Setting the search order

Select either name order or room number order for searching at the security guard station.

Start the program mode and select "SORT SETTING".

Switching between name order or room number order occurs each time the or button is pressed.



7 TECHNICAL PRECAUTIONS

TECHNICAL PRECAUTIONS

- Operating temperature: Entrance station: -10 °C to +60 °C (+14 °F to +140 °F)
Security guard station: 0 °C to +40 °C (+32 °F to +104 °F)
- Mounting location: Do not install the entrance station in a place where there would be a bright light behind a visitor (or where there would be a bright background) or in a place where the camera lens would be directly exposed to sunlight or a bright light. Entrance stations (integrated type) have a built-in people sensor, so do not place objects in places monitored by the people sensor. Also, placing the unit in very bright sunlit areas may prevent the sensor from working properly.
- Rain hood (option): Although the entrance station is weather resistant, it is recommended that it not be directly exposed to weather conditions. The rain hood can be installed to protect the entrance station from rainfall.
- Post-replacement setup: After all wiring is completed and the residential station has been replaced, turn off the power to the GT-BC temporarily and then turn it back on. Next, reprogram the relevant residential station.
- Operation: When an entrance station is calling a residential station, the call tone from the doorbell button will not sound.
- Cleaning: Clean the units with a soft cloth dampened with a neutral household cleanser. Do not use any abrasive cleaner or cloth.
- Repair requests: If there is a system malfunction, unplug the power supply and contact a qualified technician for service.

8 SPECIFICATIONS

GT-DA-L/GT-DA

- Dimensions: 93 (H) × 108 (W) × 49 (D) (mm)
3-5/8 (H) × 4-1/4 (W) × 1-7/8 (D) (inches)
- Weight: GT-DA-L: Approx. 160 g (0.35 lbs.)
GT-DA: Approx. 150 g (0.33 lbs.)

GT-VA

- Imaging element: Complementary metal oxide semiconductor (CMOS)
- Dimensions: 93 (H) × 108 (W) × 56.5 (D) (mm)
3-5/8 (H) × 4-1/4 (W) × 2-1/4 (D) (inches)
- Weight: Approx. 140 g (0.31 lbs.)

GT-NS-V/GT-NS

- Power supply: DC 24 V (supplied from PS-2420 etc)
- Current consumption: 90 mA
- Dimensions: 90.5 (H) × 106 (W) × 48.5 (D) (mm)
3-5/8 (H) × 4-1/8 (W) × 1-7/8 (D) (inches)
- Weight: Approx. 150 g (0.33 lbs.)

GT-10K

- Dimensions: 90.5 (H) × 106 (W) × 42.5 (D) (mm)
3-5/8 (H) × 4-1/8 (W) × 1-5/8 (D) (inches)
- Weight: Approx. 90 g (0.2 lbs.)

GT-SW

- Dimensions: 90.5 (H) × 106 (W) × 42.5 (D) (mm)
3-5/8 (H) × 4-1/8 (W) × 1-5/8 (D) (inches)
- Weight: Approx. 90 g (0.2 lbs.)

GT-AD

- Dimensions: 90.5 (H) × 106 (W) × 42.5 (D) (mm)
3-5/8 (H) × 4-1/8 (W) × 1-5/8 (D) (inches)
- Weight: Approx. 90 g (0.2 lbs.)

GT-DMV/GT-DM

- Power supply: DC 24 V (supplied from PS-2420 etc)
- Current consumption: 90 mA
- Video monitor: 3-1/2" color LCD
- Imaging element: Complementary metal oxide semiconductor (CMOS)
- Dimensions: 410 (H) × 150 (W) × 68 (D) (mm)
16-1/8 (H) × 5-7/8 (W) × 2-5/8 (D) (inches)
- Weight: Approx. 3 kg (6.61 lbs.)

GT-MK

- Power supply: DC 24 V (supplied from PS-2420 etc)
- Current consumption: 100 mA
- Dimensions: 210 (H) × 215 (W) × 69 (D) (mm)
8-1/4 (H) × 8-1/2 (W) × 2-3/4 (D) (inches)
- Weight: Approx. 900 g (1.98 lbs.)

Warranty

Aiphone warrants that its products have no material or workmanship defects under normal use conditions for two years after delivery to the end user. Aiphone will perform repair or replacement free of charge if the product is defective and the warranty applies to the defect. Aiphone reserves unto itself the sole right to make the final decision whether there is a defect in materials and/or workmanship and whether or not the product is under warranty. This warranty shall not apply to any Aiphone product which has been subject to misuse, neglect, accident, or to use in violation of instructions furnished, nor extended to units which have been repaired or altered outside of the factory. This warranty does not cover batteries or damage caused by batteries used in connection with the unit. Any repairs must be made at the shop or place designated in writing by Aiphone. Aiphone will not be responsible for any costs incurred during on-site service calls. Aiphone will not provide compensation for any loss or damage incurred by the breakdown or malfunction of its products during use, or for any consequent inconvenience or losses that may result.

 (WEEE) indicates applicability to the EU.

This equipment has been tested and found to comply with the limits for a Class B digital device, pursuant to Part 15 of the FCC Rules. These limits are designed to provide reasonable protection against harmful interference in a residential installation. This equipment generates, uses, and can radiate radio frequency energy, and if not installed and used in accordance with the instructions, may cause harmful interference to radio communications. However, there is no guarantee that interference will not occur in a particular installation. If this equipment does cause harmful interference to radio or television reception, which can be determined by turning the equipment off and on, the user is encouraged to try to correct the interference by one or more of the following measures: • Reorient or relocate the receiving antenna • Connect the equipment into an outlet on a circuit different from that to which the receiver is connected. Increase the separation between the equipment and receiver. • Consult the dealer or an experienced radio/TV technician for help.



AIPHONE CO., LTD., NAGOYA, JAPAN
AIPHONE CORPORATION, BELLEVUE, WA, USA
AIPHONE S.A.S., LISSES-EVRY, FRANCE