



Wall Box

5000ETP10WB

(for 5000ETP10W touch panel)

Installation Guide

⚠️ ⚠️ DANGER

HAZARD OF ELECTRIC SHOCK

Ensure that there are no electrical cables within the wall cavity at the location where the wall box cut-out will be made.

Failure to follow these instructions will result in death or serious injury.

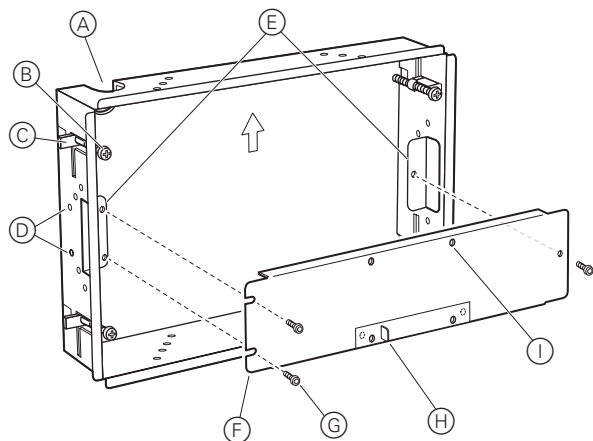

- (A) Cable access hole
- (B) Clamping screw
- (C) Clamping tab
- (D) Solid wall mounting holes
- (E) Touch panel mounting plate support
- (F) Touch panel mounting plate
- (G) Mounting plate screws (×3)
- (H) Touch panel locating guide
- (I) Touch panel mounting holes (×4)

Dimensions (mm)	Wall box main body:	W 293	H 196	D 63
	Wall box bezel:	W 316	H 220	D 6
	Clamping tab (C):	Span from box = 18 mm		

1. Creating the cut-out

- ① Noting the requirements in the diagram below, draw around the edges of this card to mark a cut-out.
- ② Create the cut-out in the wall. Finished cut-out dimensions: **W 295 mm × H 198 mm (tolerance for both = +2 mm)**
Min. depth = 65 mm.

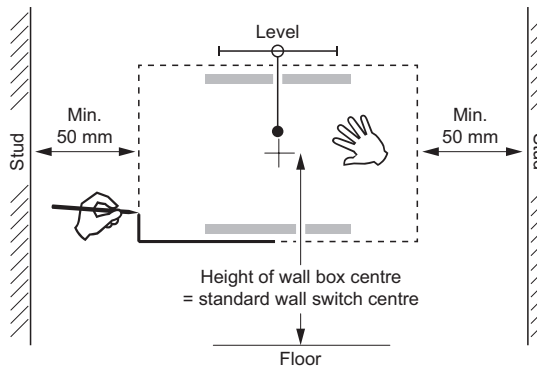

2. Preparing the touch panel cables

- ① See the touch panel instructions for required cabling.
- ② Route the cables to the cutout and terminate with appropriate connectors.

3. Installing the wall box

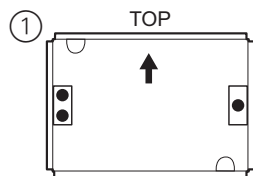

NOTICE
RISK OF CABLE DAMAGE
Ensure that cables do not foul when installing wall box into cut-out.
Failure to follow this instruction can result in equipment damage.

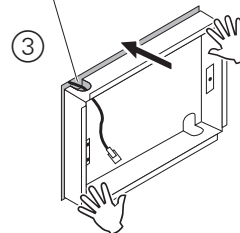
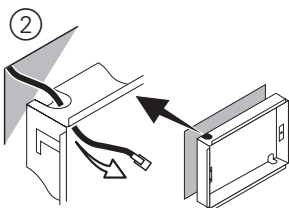

④ Plasterboard wall mounting (wall thickness: min. 9 mm, max. 34 mm)

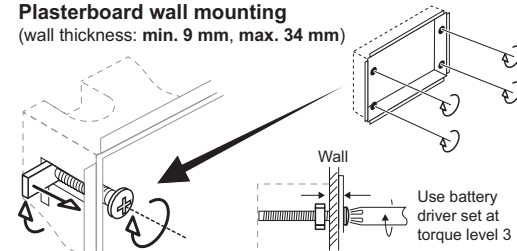

For plasterboard > 34 mm thick: Use solid wall mounting holes (see below) to screw into stud, or glue to timber.

Solid wall mounting

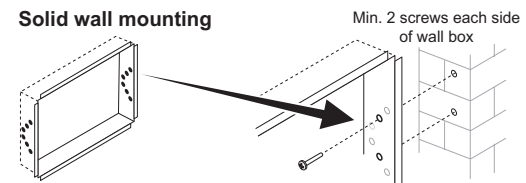

4. Installing touch panel 5000ETP10W

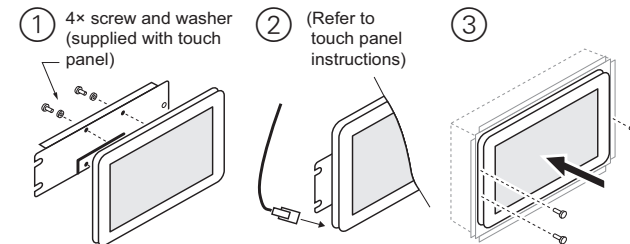

5. Installing the touch panel fascia

Note: A white fascia is supplied with the touch panel. A black fascia (5000ETP10FB) is available as a separate option.

